

Technologie

# How Russian hypersonic missiles work

---

The implementation of MHD gas flow control systems in the vicinity of these devices is the key to the performance that the Russians claim to attribute to the hypersonic weapons that Vladimir Putin revealed in 2018.

**Jean-Pierre Petit** is a french retired researcher who spent his entire career at the french Cnrs. He was in particular a pioneer in the field of bitemperature MHD between 1963 and 1987.

---

The acronym MHD means "magnetohydrodynamics". The Russian prefer "MGD", which translates as "magneto-gas-dynamics". Why "hydro"? Because initially the inventor of this range of processes is the Englishman Michael Faraday.



Michael Faraday 1791-1867

In a dynamo, an electric conductor moves in a constant magnetic field, which induces an electric field (an electromotive force) whose value is  $VB$ , where  $V$  is the speed of the conductor and  $B$  is the magnetic field intensity. This system is reversible, in the sense that if, conversely, a current with an electric intensity  $B$  flows through conductors bathed in a magnetic field  $B$ , this conductor will be subjected to a force proportional to the product  $IB$ . The dynamo then behaves like an electric motor. In Faraday MHD the conductor is a fluid. A Faraday MHD converter behaves like our dynamo (see the figures on the following pages).

When the fluid moves at a speed  $V$  in a magnetic field  $B$ , an electric field  $VB$  appears within it, which tends to cause a current to flow. The problem is that fluids, whether liquid or gaseous, unless they are liquid metals such as mercury, are very poor electrical conductors. When these MHD converters are used as electrical power generators, or as MHD accelerators, the energy involved is almost entirely dissipated by the Joule effect. Such systems are only effective when the fluid is derived from the combustion of a solid propellant, enriched in cesium, which is the substance that ionizes at the lowest temperature, around  $3000^\circ$ . The scientist Andrei Sakharov realized thus, in the Fifties, a whole range of experiments whose duration was only a few thousandths of second, but where these impulse generators could produce an intensity reaching one hundred million amperes and where metallic projectiles, vaporized and transformed into plasmas, could be accelerated to considerable speeds. Thanks to him, the Russians become leaders in this new field.

### **Velikhov instability sounds the death knell for MHD electrical generators.**

In the sixties, a number of countries, such as England, USA, France, Russia, etc., try to implement Faraday MHD generators to exploit the primary energy supplied by the combustion of hydrocarbons enriched in cesium. If the problem of electrical conductivity could be solved, these generators would offer efficiencies up to 60%, a priori much higher than those of conventional generators built around steam turbines. However, it immediately became clear that the temperatures to be reached, approaching  $3000^\circ$ , which would allow the cesium to be significantly ionized, were incompatible with the available materials (ceramic walls and electrodes). An American named Kerrebrock then suggested attempting an operation known as "non thermodynamic equilibrium" where the fluid carrying kinetic energy is considered as a mixture of two fluids: that of the heavy elements, molecules or atoms, with a « gas temperature »  $T_g$ , and the "electron gas" whose temperature  $T_e$  is then higher than that of the gas. This situation is that which reigns in a simple fluorescent tube, known as "neon tube", but where the fluid is in fact mercury vapor.

When the tube is energized, the few free electrons present are accelerated by the electric field, acquire energy and collide with the mercury atoms, releasing new free electrons in turn (the so-called "electron avalanche" effect). When the operating mode is reached, almost instantaneously, the electron gas is at several thousand degrees, while the mercury vapor remains cold (you can put your hand on the tube without getting burned). Why does this gas of electrons fail to transfer its energy? Because these electrons are much too light.

The calculation shows that this "two-temperature" state cannot be constituted in a fluid resulting from the combustion of hydrocarbons. The presence of  $CO_2$ , strongly coupled to the gas of electrons by collisions, opposes it. This one then "pumps" all the energy that the electric field  $VB$  brings to the electrons. The only solution is to use a heat exchanger and to communicate it to a rare gas like helium or argon, enriched by this "seed", cesium<sup>1</sup>

On paper this formula seems promising. By limiting the temperature of the noble gas to  $1500^\circ$ , it seemed that we could easily reach this threshold temperature of  $3000^\circ$ <sup>2</sup> (that of

---

<sup>1</sup> On this basis, the french "Typhée" machine was built at the CEA.[https://www.persee.fr/doc/helec\\_0758-7171\\_1996\\_num\\_27\\_1\\_1323](https://www.persee.fr/doc/helec_0758-7171_1996_num_27_1_1323)

<sup>2</sup> **In this document all temperature values are given in degrees Centigrade**

the incandescent filament of an electric lamp) if we would achieve a supersonic flow, a sufficient speed  $V$ , and an electric field intensity exceeding one tesla. But in 1964 a young researcher, Evgeny Velikhov, predicted the very rapid growth of a plasma instability<sup>3</sup>, to which he gave his name, causing the electrical conductivity to collapse, and therefore the prospect of satisfactory operation of the generators to vanish. One by one, all the projects were abandoned at the end of the sixties.

### **1967, France leads in MHD research, internationally**

However, there is one laboratory where a non-equilibrium operation is established, at the Institut de Mécanique des Fluides in Marseille, in 1966. Following a formula introduced by the American Bert Zauderer, the Frenchman Georges Inglesakis builds a Faraday MHD generator using the hot and dense gaseous burst provided by a kind of "plasma gun" called "shock tube". The burst of argon enters a nozzle the size of a beer can with a speed of 2.7 km/s, under a pressure of one atmosphere and with a temperature of 10,000 degrees providing electrical conductivity large enough to allow the MHD conversion to take place. During a few tens of microseconds this generator produces an electric power of several megawatts. The brevity of the contact with the gaseous burst, transformed into plasma, and the wall-electrode assembly allows that the first is made of Plexiglas and the second of red copper. The magnetic field, of 2 teslas is produced by the discharge of a bank of capacitors in solenoids traversed, for a few thousandths of a second, by a current of tens of tens thousands of amperes.

In this laboratory Jean-Pierre Petit, mastering the theory of a phenomenon<sup>4</sup> which, even today, remains unfamiliar to researchers, implements the first plasma stabilization system resulting in the following result: Gas temperature, 6000°, electrical temperature, 10.000°. This work is presented in 1968 at the Warsaw international symposium, and noticed by the Russians, masters in the field, and this is how a next international MHD symposium is held at the Institut de Mécanique des Fluides in Marseille, Velikhov having concluded that "the French are the most advanced". But this first method does not allow to lower the temperature of the gas below 4000°, so that this research is abandoned.

To illustrate the efficiency of the action of the MHD (of the "Laplace JB forces") on gases, let us quote the work of Bernard Forestier and Bernard Fontane who, on the machine built by Inglesakis manage to give to the argon burst a gain of speed of several thousand meters per second, on a length of nozzle of 10 cm. Work of major importance, to which France did not pay attention either.

### **Birth of an idea.**

Back to the theme of MHD electricity production, the installation of the Marseille laboratory is the only one in the world where a significant part of the kinetic energy of the

---

<sup>3</sup>[https://en.wikipedia.org/wiki/Electrothermal\\_instability#:~:text=The%20electrothermal%20instability%20occurs%20extremely%20quickly%2C%20in%20a,plasma%20appears%20stratified%2C%20as%20a%20%22pile%20of%20plates%22](https://en.wikipedia.org/wiki/Electrothermal_instability#:~:text=The%20electrothermal%20instability%20occurs%20extremely%20quickly%2C%20in%20a,plasma%20appears%20stratified%2C%20as%20a%20%22pile%20of%20plates%22)

<sup>4</sup> [http://www.jp-petit.org/papers/CRAS/mhd\\_1969d.pdf](http://www.jp-petit.org/papers/CRAS/mhd_1969d.pdf)

plasma is converted into electricity, due to the high electrical conductivity of argon heated to  $10,000^\circ$ . The fluid undergoes an intense slowing down, generating the appearance of a straight shock wave, established at the entrance of the nozzle, of constant square section. This suggests that by acting on an ionized fluid flowing at supersonic speed on an object, a vehicle, it should be possible a priori to prevent the shock waves from occurring, with what they immediately entail: an increase in drag (the "wave drag") and in the flow of heat collected by the vehicle. Very quickly Petit, who in the meantime left the IFM to join the Marseille observatory where he pursues work on galaxy dynamics, considers the theoretical context of this shock wave annihilation system. To illustrate it, we will use the hydraulic analogy. Indeed, the waves that propagate on the free surface of a liquid are equivalent to the propagation of sound waves. If we plunge a simple toothpick in the water flow of a weir, it does not produce any surface wave. When the speed exceeds the speed of surface waves (analogous to the speed of sound in a gas) two wavelets are formed, analogous to "Mach waves" in a gas.<sup>5</sup>

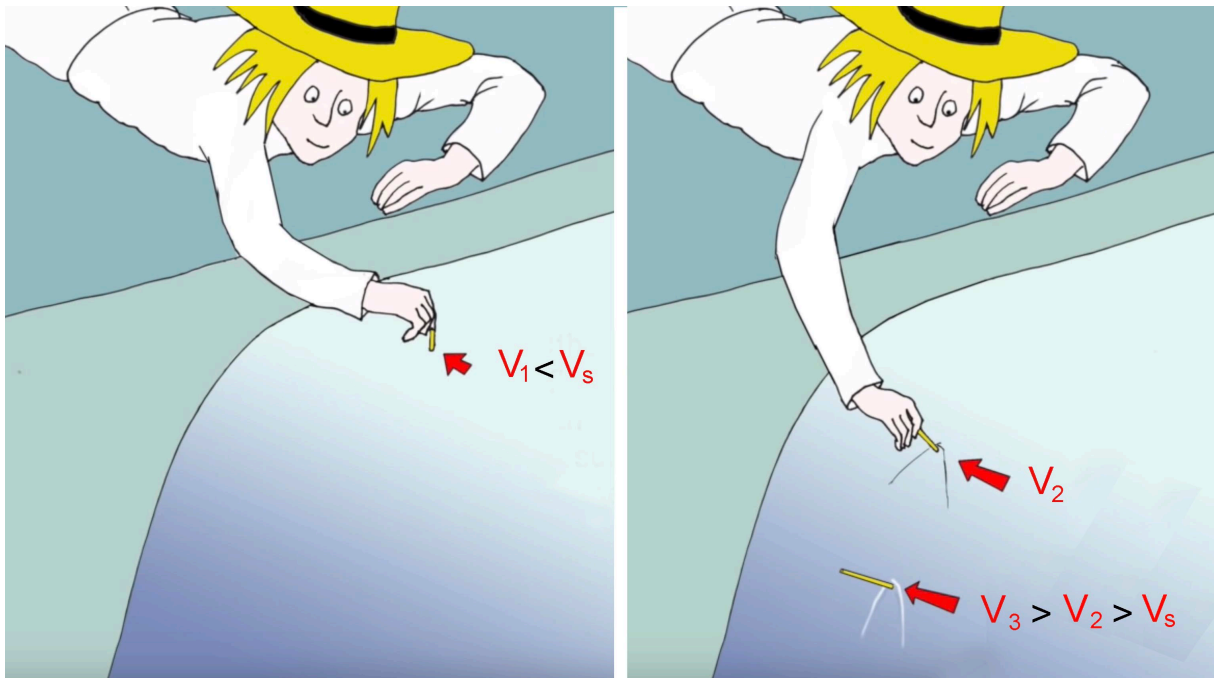

*On the left, the speed  $V$  of the water is lower than  $V_s$ , the speed of the surface waves: no waves. On the right this speed is exceeded. When it increases, the waves lie down more and more.*

The angle  $\alpha$  formed by these wavelets and the direction of flow immediately gives the velocity of the fluid, the velocity  $V_s$  being known, according to the formula :

<sup>5</sup> See the two videos :

<https://youtu.be/Jn8b3E9oUHY>

<https://youtu.be/22oFoWcg1qs>

$$\frac{V}{V_s} = M \text{ (Mach number)} = \frac{1}{\sin \alpha}$$

Now look at water flowing in a gutter. The irregularities at the wall generate these "Mach waves" which form a set of parallel wavelets (since the speed of the water is constant). But these wavelets curve at the free edge of the flow, and eventually disappear. This is because the friction of the water on the bottom, decreases its speed. They disappear when  $V$  becomes lower than  $V_s$ . The flow at the edge of this channel then becomes "subsonic".

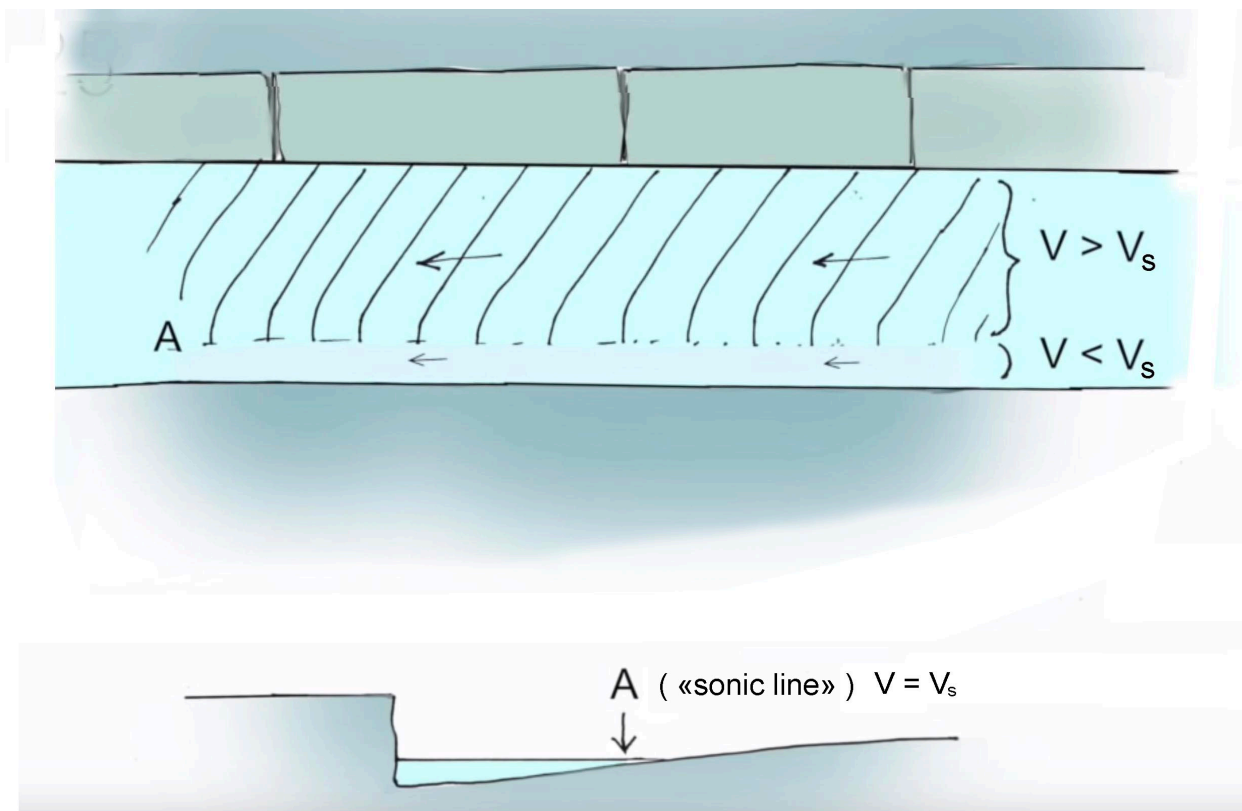

*Water flow in the gutter, bird's eye view.*

### **Why shock waves form.**

A little further on the street turns, as indicated. The wavelets lie down, the velocity increases and the thickness of the water film decreases. This is the analogue in a supersonic flow of an "expansion fan". We will see later.

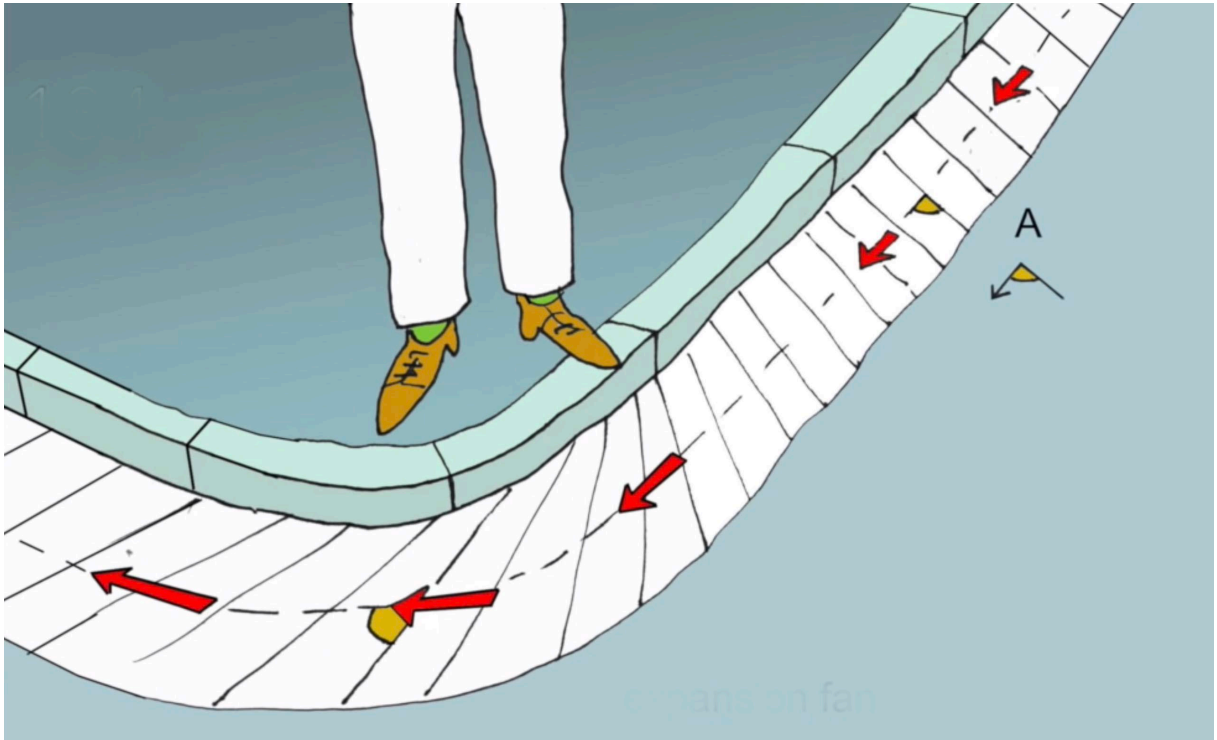

Another configuration, see below. The velocity decreases. The wavelets accumulate and a jump appears, where the height of the water increases abruptly and the speed of the water decreases. It is the faithful analog of a shock wave.

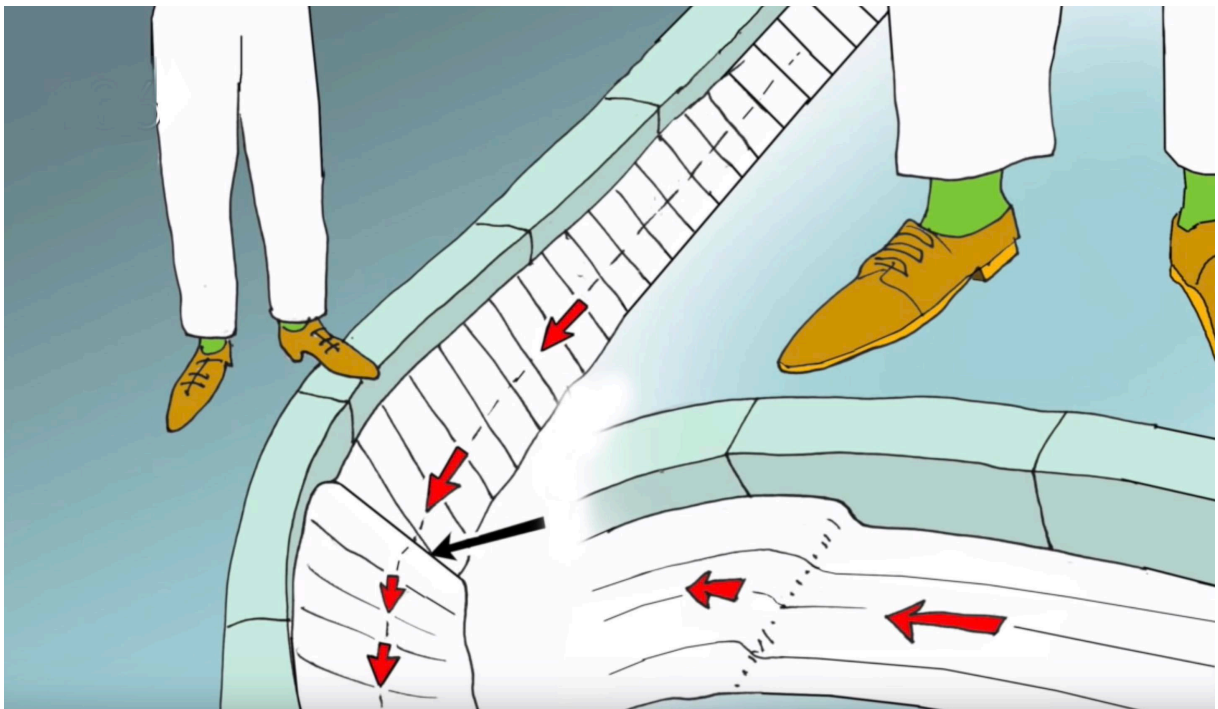

What produces these phenomena?

These are the forces of inertia.

Let us now consider a ship's hull that moves in water. This experiment can be carried out in a hydraulic analogy basin. If the relative speed of the fluid with respect to this hull exceeds that of the surface waves, the wavelets will tend to accumulate on both sides. Bow and stern waves will form, which will attach to the bow and stern of this hull. See figure below.

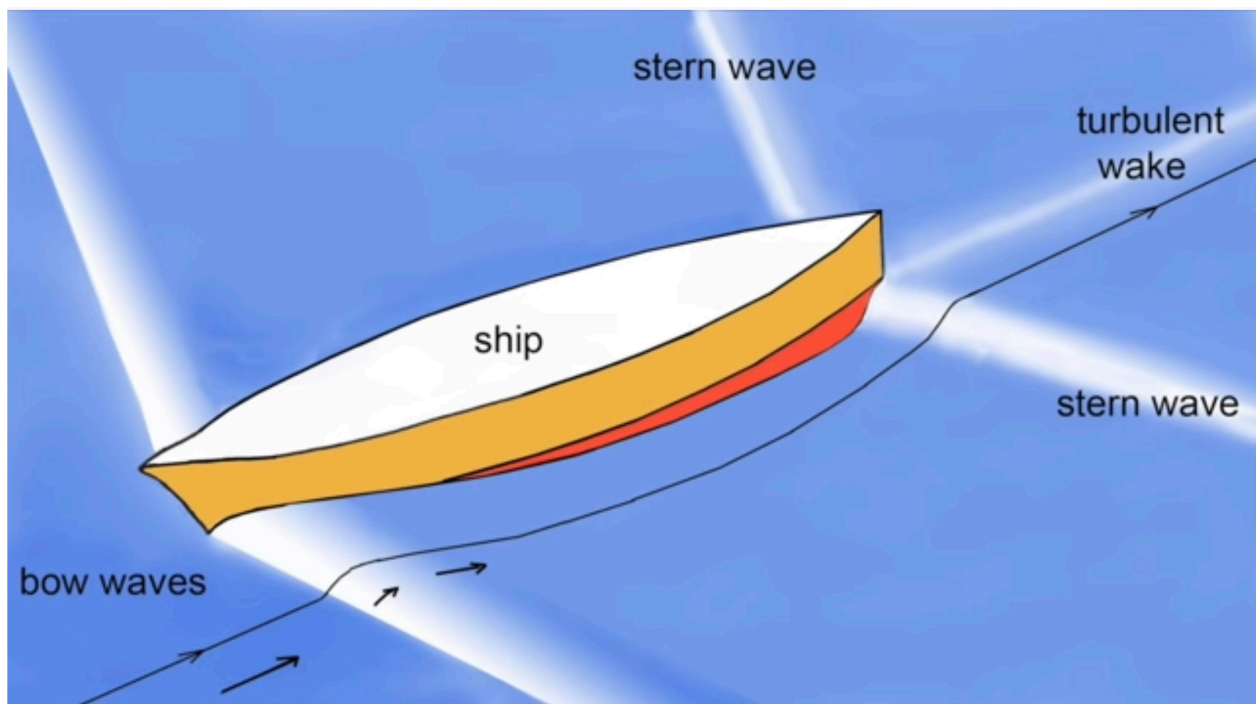
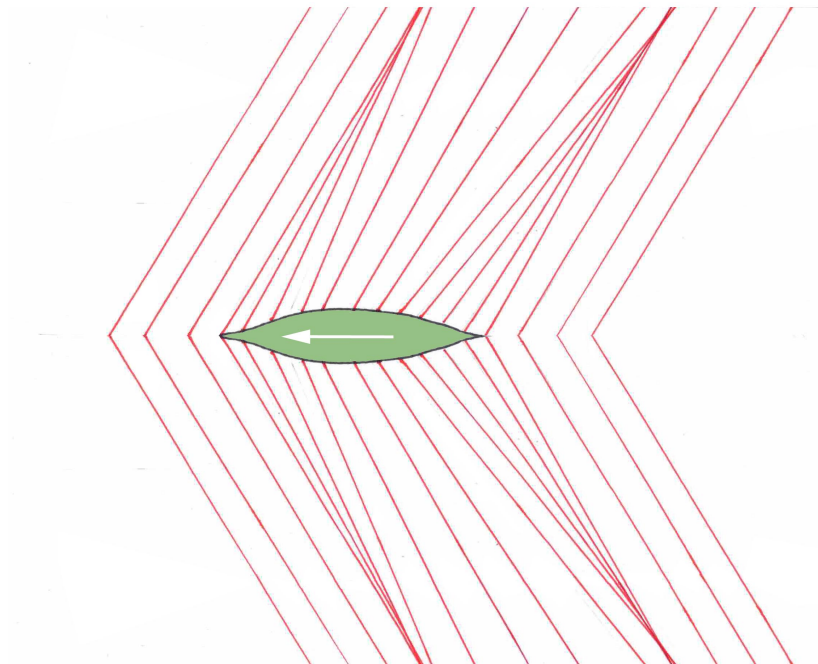

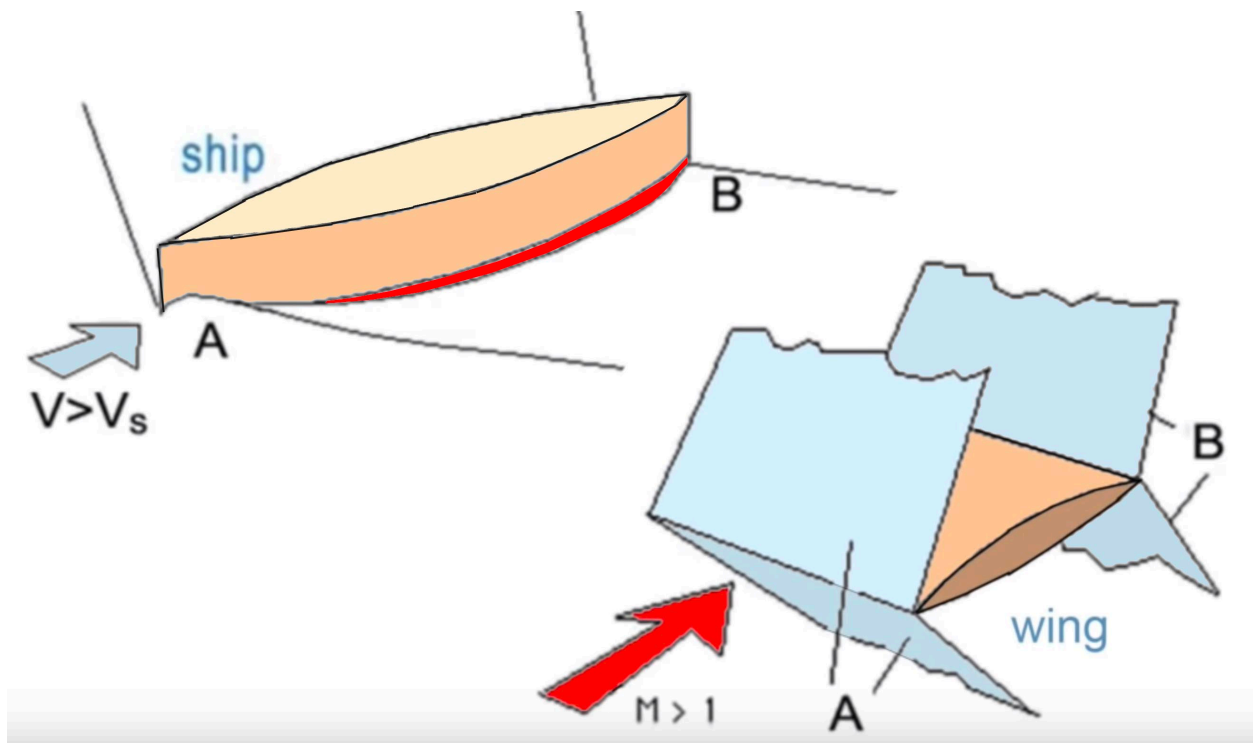

### Wave drag.

The bow and stern waves, around this hull, are the faithful analogues of the frontal and "stern" shock waves, which originate on a wing profile immersed in a supersonic gas current. It is immediately apparent that this causes drag in addition to the frictional drag, which is due to inertial forces. Immediately downstream of the bow wave the water level rises sharply, which is accompanied by an overpressure on the hull. Conversely, the water level along the sides drops below the waterline, which means a drop in hull pressure. The combination of the two gives an increase in the force to overcome to move. Analogous phenomenon in a gas, generating a wave drag, which does not exist in subsonic (in hydraulic the water level remains constant along the profile, corresponding to the waterline)



## cross section of an aircraft wing placed in a supersonic current

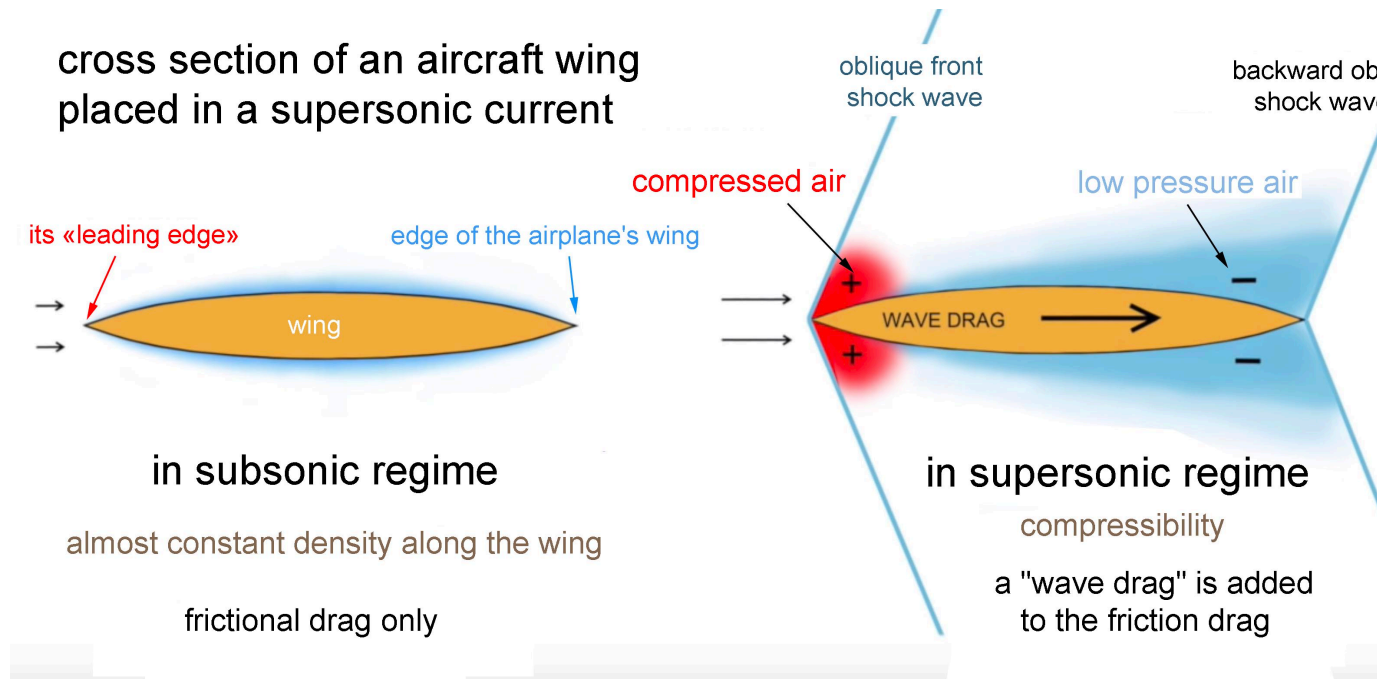

In the vicinity of the leading edge, when crossing the shock wave, the air is suddenly recompressed and therefore heats up. On the leading edge there is a "stagnation point" where all the kinetic energy of the incident air is converted into (absolute) temperature. This one thus varies as the square of this speed, thus of the "Mach number". We can thus see the problems that appear in supersonic regime. For an aircraft like the Concorde, flying at Mach 2, the stop temperature reaches 250°. At the wall, because of the friction, this temperature reaches 200°. The phenomenon of the wave drag doubles the global drag. Beyond we have the American SR-71 aircraft flying at Mach 3.2. Add 100 degrees to these temperatures. In his cabin the pilot wears a refrigerated suit. It is impossible for him to touch the windows of his cockpit, raised to 300°



Beyond Mach 5 is the domain qualified as hypersonic. Current air-to-air missiles are in this Mach number range. The Patriot anti-missile missile, which must be given a maximum speed, climbs towards its target at Mach 6. The thermal effects are then significant, but these devices operate for limited times.

In 2018 Vladimir Putin announced that Russia has an air-to-air missile Kinjal (the dagger) flying at Mach 10, at ten times the speed of sound in dense air, with a range of one thousand kilometers, which implies a flight time of up to ten minutes. In a recent article in Scientific American two specialists express doubts about its existence<sup>6</sup>. Indeed, on the basis of a conventional fluid mechanics, the stopping temperature reaches a value of several thousand degrees, incompatible with the behaviour of the existing materials. But Putin specifies that, on this machine, the temperature does not exceed 1400°C.

### **A new "active" fluid mechanics.**

In 1976 Jean-Pierre Petit laid the foundations of a new "active" fluid mechanics where the flying machine no longer passively undergoes the incident air flow. It then acts on this air by ionizing it, making it an electrical conductor<sup>7</sup>. Then, using a magnetic field and an electric discharge associated with a set of electrodes, it exerts a force on the surrounding air mass. Let us give some figures. Let us calculate the volume of air surrounding the missile at one cubic meter. The missile then creates a magnetic field of one tesla and an electric discharge corresponding to one ampere per square centimeter. As a result, the force exerted on this mass of air is one ton. We discover here the extreme efficiency of these forces (of Laplace), when they act on these light objects that are gases.

The two drawings below show the two types of operation of a Faraday converter. On the left, operation as a plasma gas pedal. Energy must be supplied. The Mach lines lie down. On the right, operation as an electricity generator. The Mach lines are rectified. This straightening can go as far as their accumulation, hence the birth of the right shock wave observed by Jean-Pierre Petit in 1966 in his experiments at the Institute of Fluid Mechanics in Marseille.

---

<sup>6</sup> <https://www.scientificamerican.com/article/the-physics-and-hype-of-hypersonic-weapons/>

<sup>7</sup> See the « scientific comic book », « THE SILENCE BARRIER »  
<http://www.savoir-sans-frontieres.com/download/eng/mursilence.htm>

### Faraday accelerator

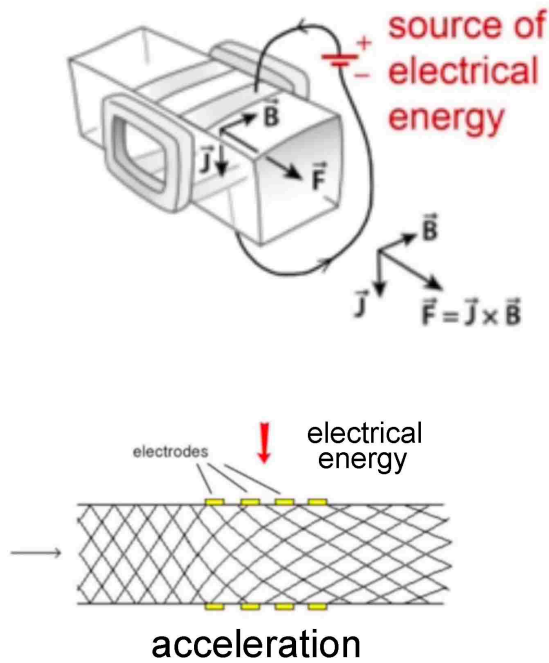

### Faraday generator

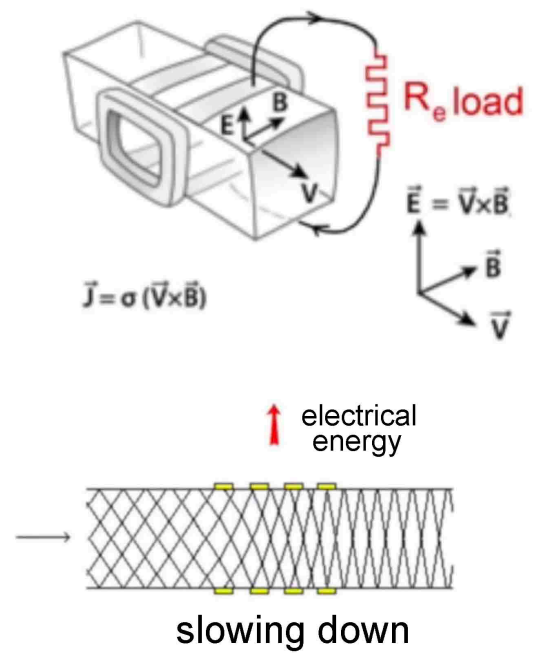

Shock waves take place where Mach waves accumulate. This is the reason why, in the experiments conducted in 1965 by Petit, a straight shock wave was created, which migrated towards the nozzle inlet, in the same way that shock waves, on a wing profile, migrate immediately to the leading edge.

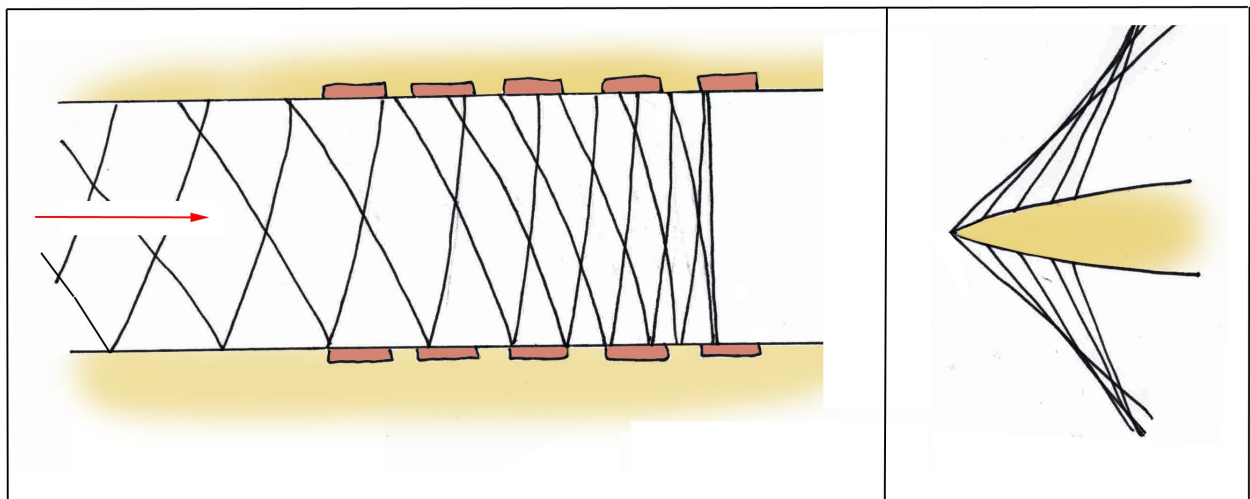

However Petit thus notes that by implementing an adequate Laplace force field, one can act on the geometry of the Mach lines. We can thus maintain their parallelism, and thus remove the primary cause of the appearance of shock waves. He entrusted his student,

Bertrand Lebrun, with the task of carrying out numerical simulations where the plasma must be accelerated at the leading and trailing edges of a lenticular profile, equipped with parietal electrodes, and on the contrary accelerated on the flanks, thanks to a third pair of electrodes. Previously, in 1977 a hydraulic simulation had been successful.

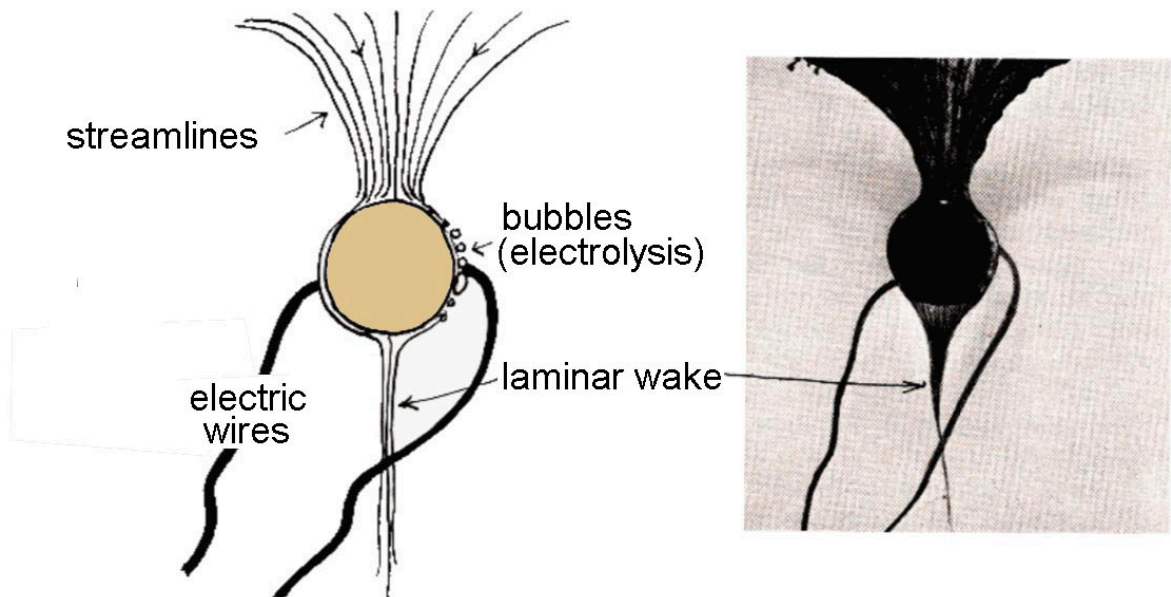

**1976 : suppression of the turbulent wake by the Lorentz forces**

See figure above. Around a small model, placed in a flow of acidulated water simulating a supersonic flow at Mach 1.4, equipped with three pairs of electrodes and placed in a magnetic field of one Tesla, the bow and stern waves had been annihilated:

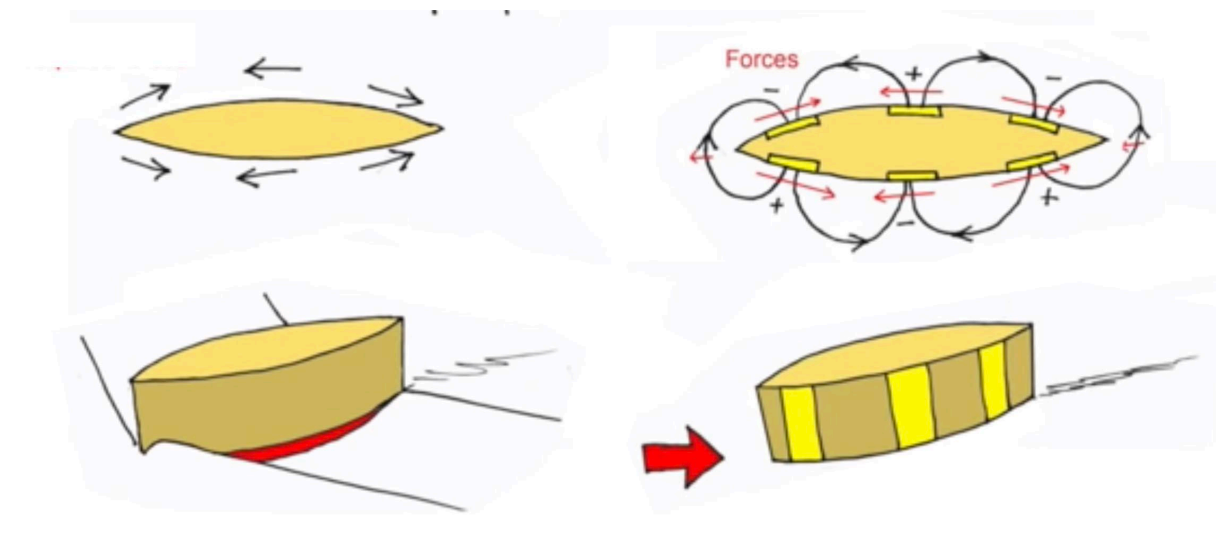

*The annihilation of bow and stern waves, 1977*

Petit and Lebrun then undertook to calculate the supersonic flow around a similar model, immersed this time in a flow of argon at 10,000 degrees, thus good conductor of electricity. This implies an alternation of energy input and output, the energy to be provided to make the shock waves disappear being the difference of the two. The calculation is carried out on five Mach Intosh personal computers, working in network, thanks to a data transfer on 3 inches diskettes. Only one of these machines was not able to manage such a calculation. Here is the result obtained, at the beginning of the eighties

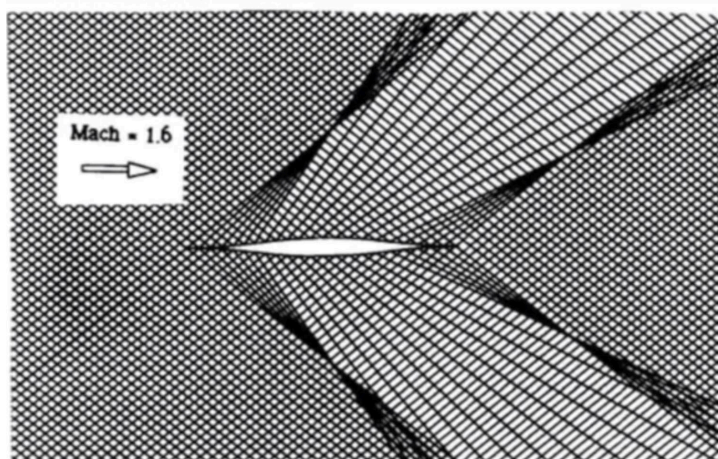
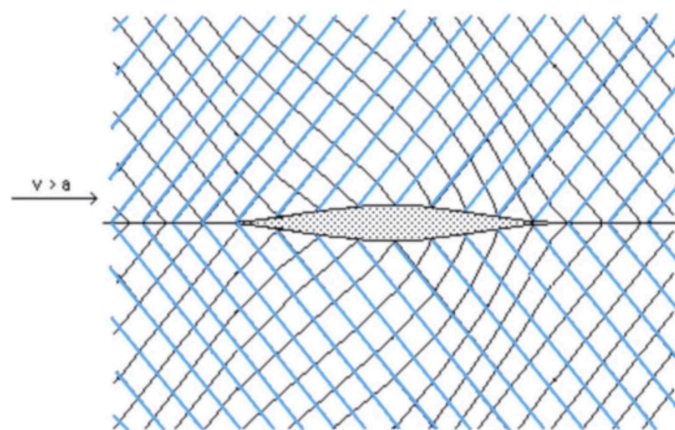

Figure 43 : Ecoulement externe autour de l'aile mince.  
Intersection des caractéristiques en l'absence  
du champ de force  $\mathbf{J} \times \mathbf{B}$ . Mach amont = 1.6 .



The blue lines are parallel : shocks avoided

Fig.5 Mach lines from action of the  $\mathbf{J} \times \mathbf{B}$  force field

As can be seen on the figure on the right there is no more accumulation of Mach waves, sign of the birth of shock waves. The feasibility of supersonic flights without shock waves (the annihilation of turbulence had also been demonstrated in 1975) is thus demonstrated. This work is duly published in a high level physics journal<sup>8</sup>.

These ideas of shock wave annihilation also spread to Russia, where Petit presented them at an international MHD meeting<sup>9</sup>, where he went at his own expense in 1983. The same ideas were exported to China in 1992, during an international MHD symposium<sup>10</sup> where he could not attend, due to a lack of funds.

### Eighties: the French MHD, continuation and end.

The calculations carried out by Petit and Lebrun consist in calculating all the parameters of a shock wave suppression experiment in a hot argon shock driven wind tunnel, similar to the one built by Petit in his laboratory in Marseilles in 1965:

<sup>8</sup> <http://www.jp-petit.org/papers/MHD/1989-EurJMech-1.pdf>

<http://www.jp-petit.org/papers/MHD/1989-EurJMech-2.pdf>

<sup>9</sup> <http://www.jp-petit.org/papers/MHD/1983-Moscow-shockwave.pdf>

<sup>10</sup> <http://www.jp-petit.org/papers/MHD/1992-Beijing-shockwave.pdf>

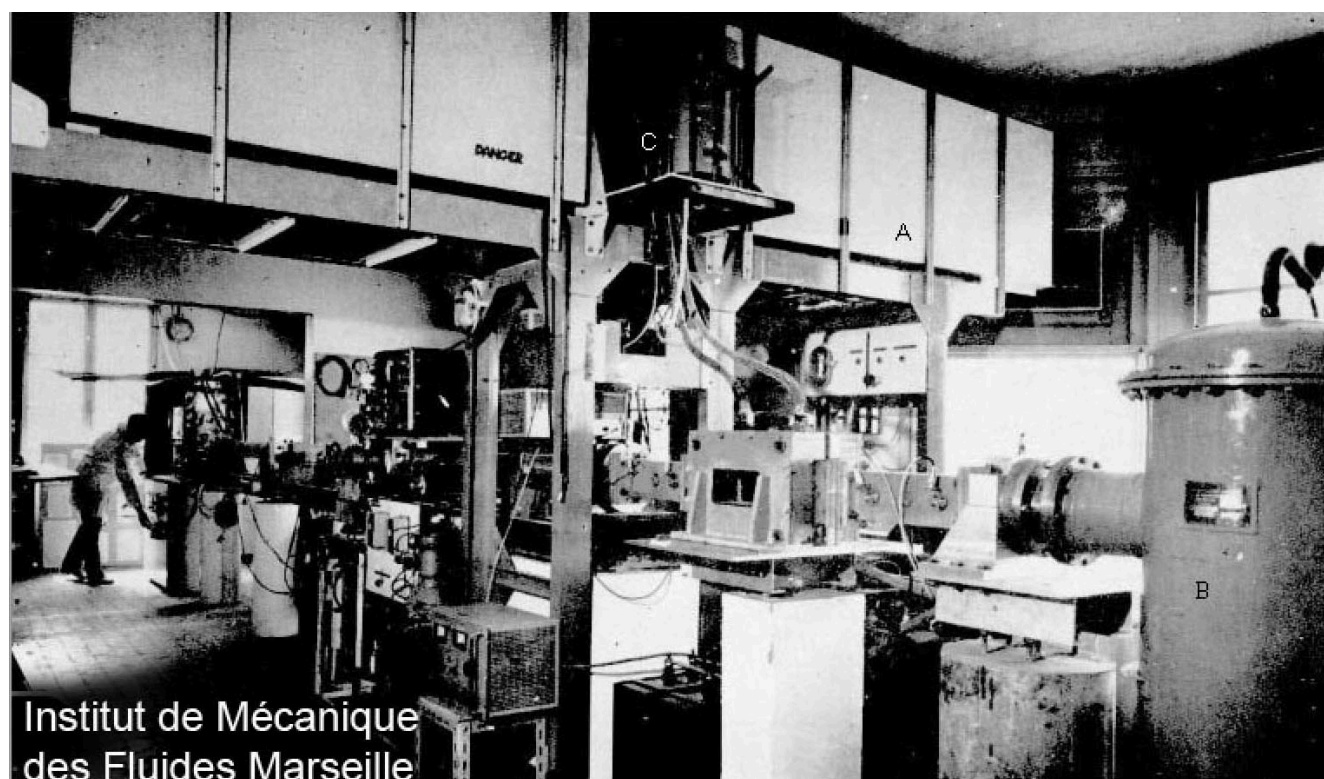

*Jean-Pierre Petit's hot shock driven wind tunnel, in 1965.*

We are in the middle of the eighties. The French laboratory CORIA, in Rouen, has this type of hot argon wind tunnel. Petit suggests to equip it with capacitors and solenoids to realize the key experiment corresponding to Lebrun's thesis. A Cnrs contract is thus elaborated. But the Army intervened. For the army, such research is a matter of defence secrecy. Petit, like his friend the mathematician Alexandre Grothendieck, was hostile on principle to any concealment of scientific results. He was then dismissed from the contract and the project, deprived of his directives and managed by researchers with no expertise in plasmas, quickly turned into a fiasco. His eviction is moreover motivated by considerations that can be qualified as extrascientific<sup>11</sup>. Although he had reoriented his research towards cosmology<sup>12</sup>, Petit continued his experimental work in a makeshift laboratory installed in a maid's room in Aix-en-Provence. He operated in low pressure air, which corresponds to the flight conditions of hypersonic gliders. Advanced researches, very sophisticated on the theoretical level, are then carried out with material discarded by laboratories of the region.

<sup>11</sup> <http://www.jp-petit.org/papers/MHD/1977-Petit-Viton-aerodyne2.pdf>

<sup>12</sup> <https://youtu.be/DtWqAK4mVX0>

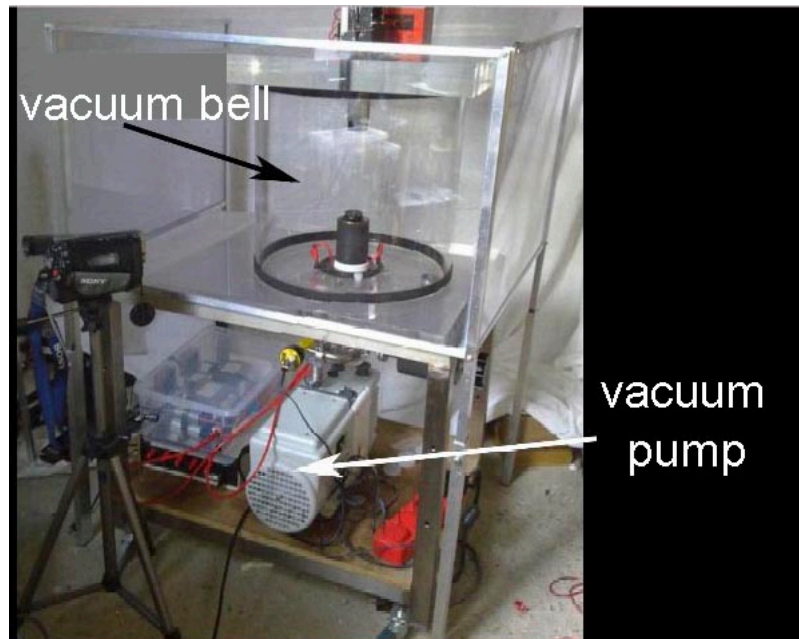

*J.P.Petit's makeshift laboratory*

The suppression of shock waves and in general the implementation of MHD systems on spacecrafts evolving at hypersonic speed faces two problems: the electrothermal instability of Velikhov<sup>13</sup> and the parietal deconfinement of plasma in the vicinity of the spacecrafts.

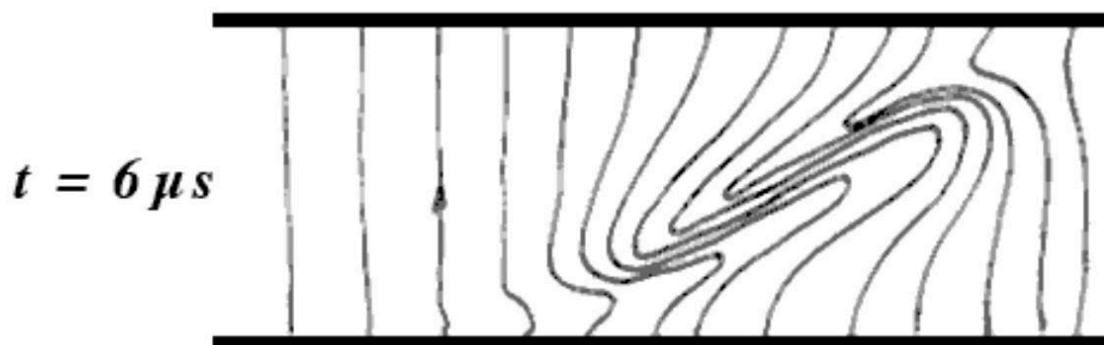

Distortion of the electric current lines by the electrothermal instability of Velikhov

Petit is one of the few scientists, thanks to his skills as a theorist, to master the instabilities of plasmas. In 1969 he calculated the conditions for the development of the Velikhov instability<sup>14</sup>. At the beginning of the eighties he imagined in 1981 the definitive

<sup>13</sup>[https://en.wikipedia.org/wiki/Electrothermal\\_instability#:~:text=The%20electrothermal%20instability%20occurs%20extremely%20quickly%2C%20in%20a,plasma%20appears%20stratified%2C%20as%20a%20%22pile%20of%20plates%22](https://en.wikipedia.org/wiki/Electrothermal_instability#:~:text=The%20electrothermal%20instability%20occurs%20extremely%20quickly%2C%20in%20a,plasma%20appears%20stratified%2C%20as%20a%20%22pile%20of%20plates%22)

<sup>14</sup> [http://www.jp-petit.org/papers/CRAS/mhd\\_1969d.pdf](http://www.jp-petit.org/papers/CRAS/mhd_1969d.pdf)

way to control the Velikhov instability<sup>15</sup>. To prevent the electric discharge from being the seat of violent turbulence, it must be maintained with the help of "magnetic foils". And, as far as plasma is concerned, these "foils" are in fact the regions with strong magnetic fields. Once again, the experiment is a success and this result is also presented in Russia in 1983<sup>16</sup>. In the wake Petit exploits this concept by operating the parietal confinement of plasma<sup>17</sup>.

### Russian hypersonic missiles.

In the middle of the eighties, Evgeny Velikhov became vice-president of the USSR Academy of Sciences and scientific advisor to the Kremlin on defense matters. After reading the articles presented by Petit, he understood that the latter had solved the fundamental problems associated with any implementation of hypersonic missiles. Russia therefore undertook, in the greatest secrecy, to position itself in this new field, of major strategic importance. Several axes are envisaged. The Russians have mastered, since the beginning of the eighties, the production of electricity by Pavlovski generators.



*Geophysical Pulsed MHD Generator "Pamir-2"*

These are MHD generators exploiting the energy generated by the combustion of solid propellants doped with cesium. The magnetization systems work by self-excitation. The power produced is in the tens of megawatts, for several minutes. The electrical energy delivered by these generators can then supply parietal electrodes and ionization and magnetization systems that represent the concretization of the principles described by Petit in the mid-1970s. This will lead years later to the Kinjal air-to-air or ground-to-air missile, flying at Mach 10 in dense air and with a range of one thousand kilometers. On the available photos a conical cap equips the missile during its transport under a Mig-29 aircraft. It is ejected when the MHD system comes into action, revealing the arrangement of

<sup>15</sup> [http://www.jp-petit.org/papers/CRAS/mhd\\_1981.pdf](http://www.jp-petit.org/papers/CRAS/mhd_1981.pdf)

<sup>16</sup> <http://www.jp-petit.org/papers/MHD/1983-Moscow-instability.pdf>

<sup>17</sup> <http://www.jp-petit.org/papers/MHD/2011-ActaPhysPolA.pdf>



its electrodes and its straight, not pointed, leading edge. The hypersonic flow is controlled at all points, not only at the front part of the aircraft, but on all the wall, thanks to a parietal acceleration system, initially invented by the American engineer West, reinvented and actively studied by J.P.Petit. See this video<sup>18</sup>. The missile changes direction, not with the help of aerodynamic control surfaces, of limited effectiveness, but by playing on the intensity of the Laplace forces, i.e. by using an "MHD piloting system", which gives it an exceptional agility. Its ability to approach its target at low altitude puts it out of radar range for most of its course. The plasma shell that surrounds it, absorbing the laser shots, puts it out of reach of these ultimate defense systems. There is no countermeasure against such a weapon, recently deployed by the Russians in Ukraine, which can carry conventional or nuclear charges. This parietal thruster system had been used by the Russians to provide low-speed, silent propulsion for nuclear submarines. When it was decided in the country to reposition itself strategically to face the development by the Americans of anti-missile systems, following their unilateral denunciation of the SALT agreements, the Russians quickly designed a Poseidon submarine drone, electrically powered by a nuclear reactor. A hull, thicker than that of submarines, allows it to approach its target by evolving at a depth of 1,200 metres and at a speed of 200 km/h, reached thanks to a parietal MHD propulsion, which puts it beyond the reach of any interception by torpedoes. A 100 megaton charge, ignited near a coastline, generates a 500 m high tsunami, capable of devastating the whole south of England, leaving on the surface a land poisoned by radioactive waste.

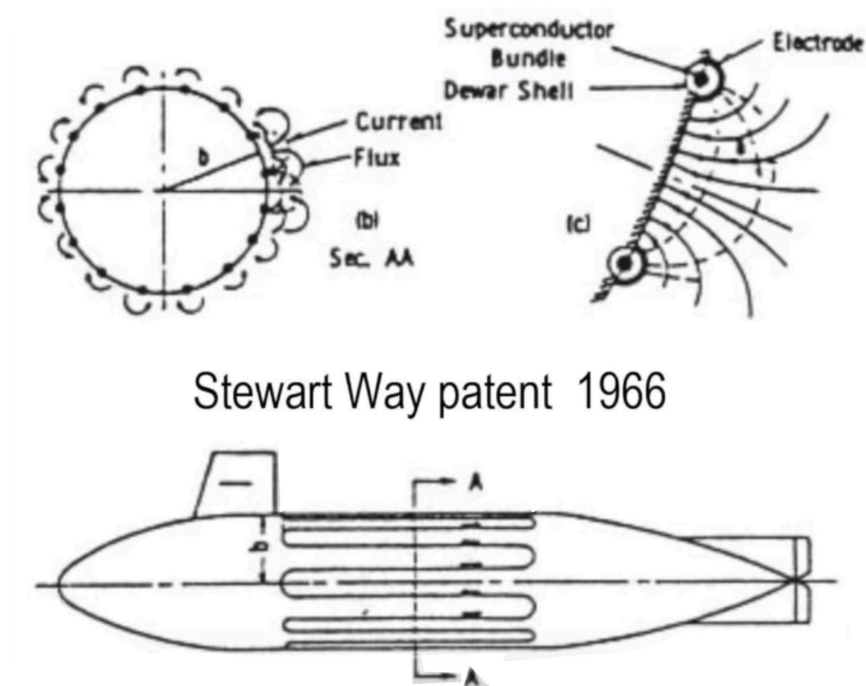

*The parietal MHD propulsion system, invented by the American engineer Stewart West*

The Avangard hypersonic glider is a composite craft. A part of its surface, equipped with parietal MHD electricity generators, feeds the parts intended to annihilate the shock waves and to cancel the drag. It is called « MHD bypass ».

<sup>18</sup> <https://youtu.be/sGViQxiijho>

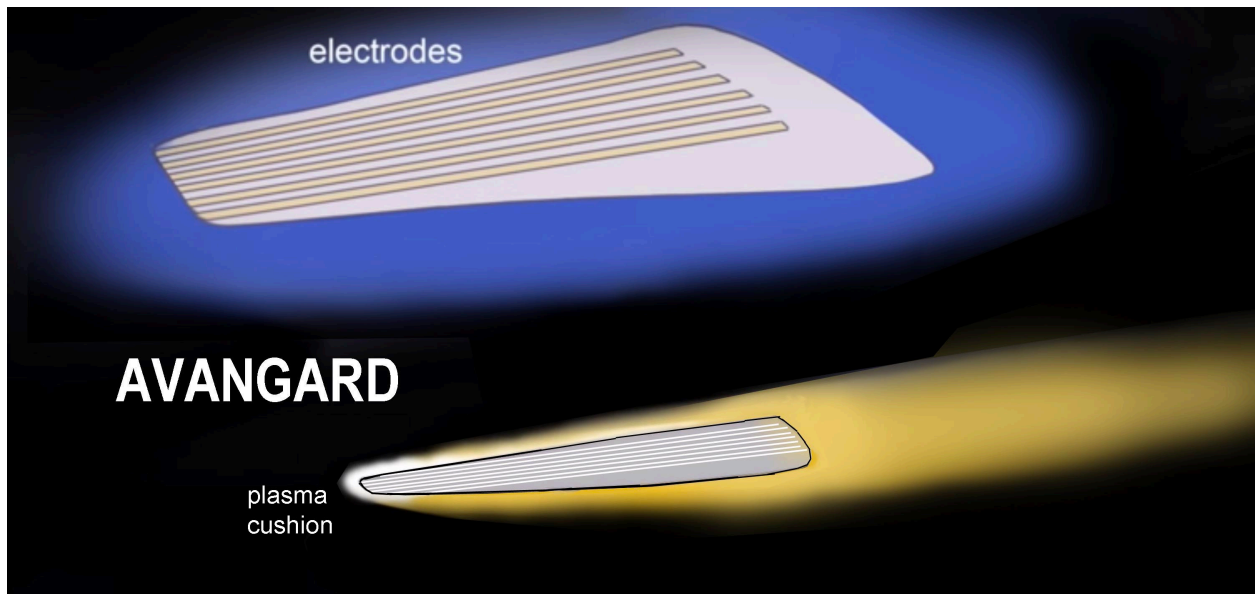

### What is frictional drag?

When a vehicle moves in a fluid, the molecules of mass  $m$  in immediate contact with the wall become embedded in it for a brief moment. They are then given the speed  $V$  of the object, thus a quantity of movement  $mV$ , oriented in the direction of the movement. When they are released in the ambient fluid, they communicate this extra quantity of movement to their fellow molecules. This quantity of movement is thus transmitted, from one to another, through what is called the boundary layer. In order to maintain its speed, a machine will have to implement a propulsion system which opposes this quantity of movement permanently transmitted by the fluids. In other words this thrust will have to deal with this frictional force, or drag. This phenomenon is all the more important as the fluid is dense. Thus the friction exerted on torpedoes is opposed to their progressing at a speed well above 100 km/h.

A solution, implemented by the Russians since 1970, consists in reducing this friction by replacing the fluid in contact with the torpedo, water, by water vapour, which the torpedo creates by injecting a very hot combustion gas at the front end. This is how their Shkval torpedo<sup>19</sup> works, propelled by a powder rocket and wire-guided.

<sup>19</sup> [https://en.wikipedia.org/wiki/VA-111\\_Shkval](https://en.wikipedia.org/wiki/VA-111_Shkval)

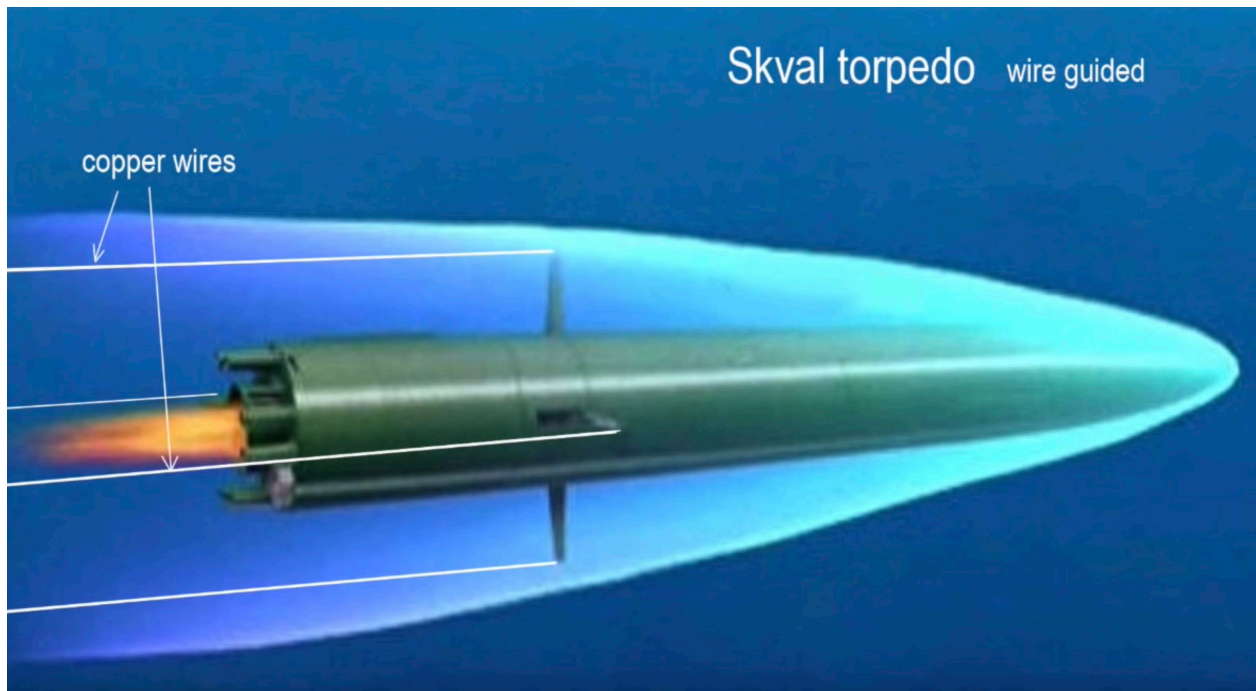

Hereafter, its nozzle of injection of the gas resulting from the combustion of a solid propellant:

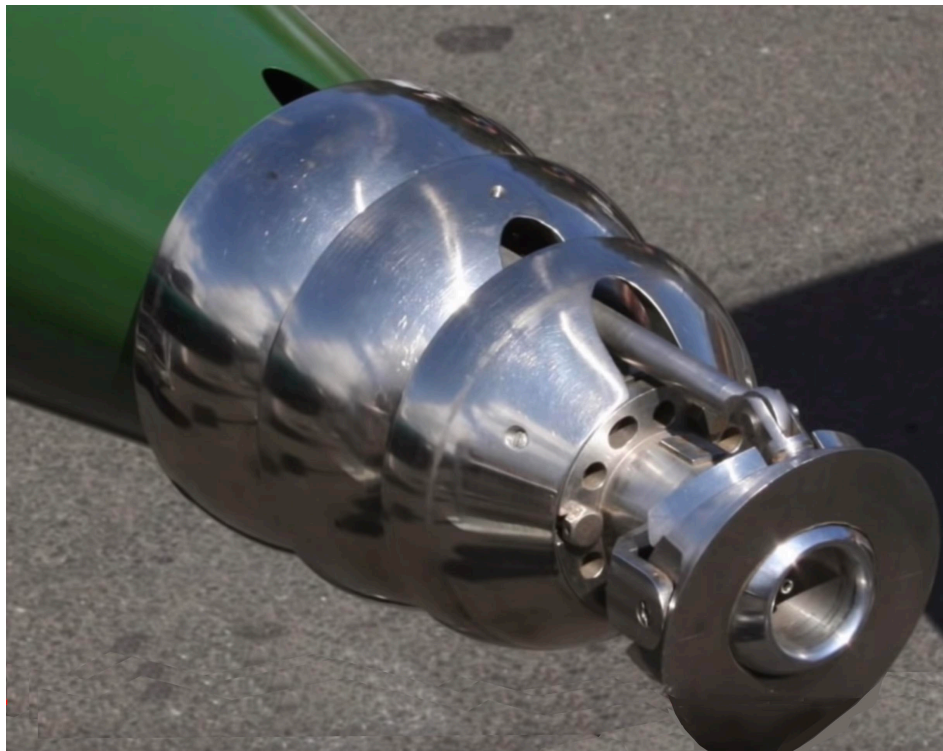

Adjustable by means of simple actuators it allows the flow of gas injected on one side or the other of the torpedo to be modulated. This creates a differential friction on opposite walls and thus represents an extremely effective means of piloting the machine, fundamentally different from the classic ailerons, or the swivel nozzle system.

### **Cancel the frictional drag by MHD.**

Stewart West's parietal gas pedal not only cancels friction, but also reverses it. It then becomes the propulsion mode of the machine. This is the propulsion mode of the Russian Poseidon underwater drone, much quieter than propellers.

Here again, the modulation of friction replaces the classic aerodynamic (or hydrodynamic) control surfaces, which gives your machines incomparable agility. Light and small, Avangard evolves like a pebble ricocheting on the surface of the water, in the very high layers of the atmosphere. Avangard is not a "wave rider", a machine that ensures its lift thanks to the overpressure associated with the shockwave on its lower part, whose L/D glide ratio<sup>20</sup> does not exceed a few units, because of the important drag inherent to the presence of shockwaves, and to friction. With the cancellation of the whole of its drag by the MHD the glide ratio of Avangard becomes on the contrary very important. Its MHD piloting, at altitudes ranging from 40 to 80 kilometers, gives it the possibility of approaching its target by zigzagging over thousands of kilometers without being detected, and the plasma cocoon which surrounds it gives it stealth and protects it from laser fire, which makes it practically impossible to intercept.

The American defense system, was essentially deployed to deal with ballistic missiles, after flying over the North Pole. Their Aegis system, installed on board ships, completes this system and aims at protection from the oceans, but remains of an imitated range. To bypass such a defence system, the Russians have built a heavy Sarmat missile<sup>21</sup>, weighing 200 tonnes, capable of carrying 10 tonnes of payload. It is no longer strictly speaking a ballistic missile in the sense that the speed communicated to the payload reaches the speed of orbit, which makes it possible to envisage circumterrestrial trajectories, flying over the South Pole at a relatively modest altitude, which makes it possible to escape radar detection. In terminal phase the machine can deliver up to twenty four small hypersonic Avangard gliders.

To complete this panoply, the Russians took back an American project of the Fifties, the Pluto project<sup>22</sup>.

---

<sup>20</sup> where L is the distance the glider can travel while losing altitude D

<sup>21</sup> [https://fr.wikipedia.org/wiki/RS-28\\_Sarmat](https://fr.wikipedia.org/wiki/RS-28_Sarmat)

<sup>22</sup> [https://fr.wikipedia.org/wiki/Projet\\_Pluto](https://fr.wikipedia.org/wiki/Projet_Pluto)

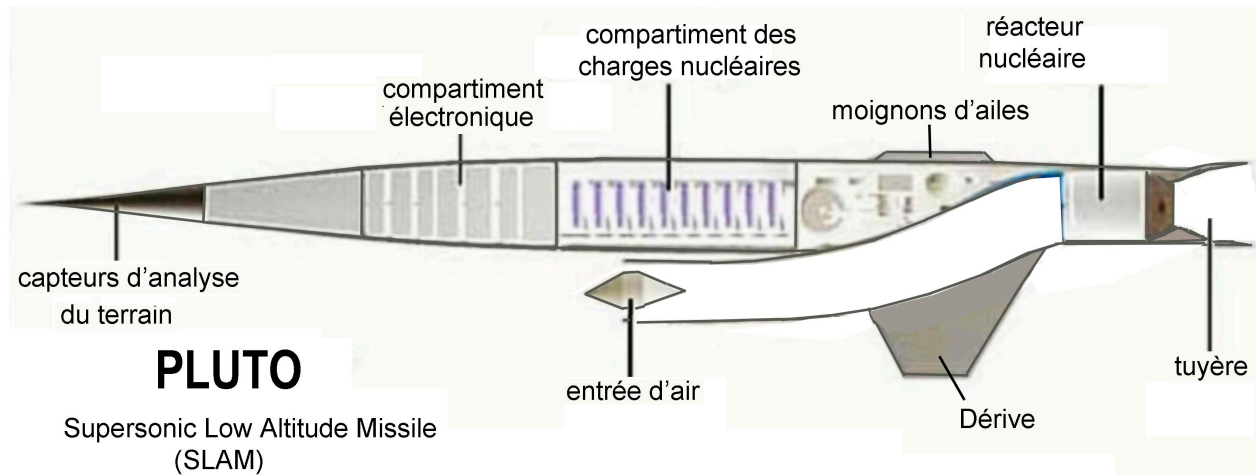

It is then a heavy cruise missile, evolving at low altitude at Mach 3. It is equipped with a thermopropulsive nozzle, a kind of ramjet where the air is brought to 1200° after passing through a hundred tubes ensuring the cooling of a mini nuclear reactor, without any armour. It is represented installed on a platform mounted on rails. It is then propelled by powder boosters before its nuclear engine enters in action. Hereafter the nuclear engine of Pluto:

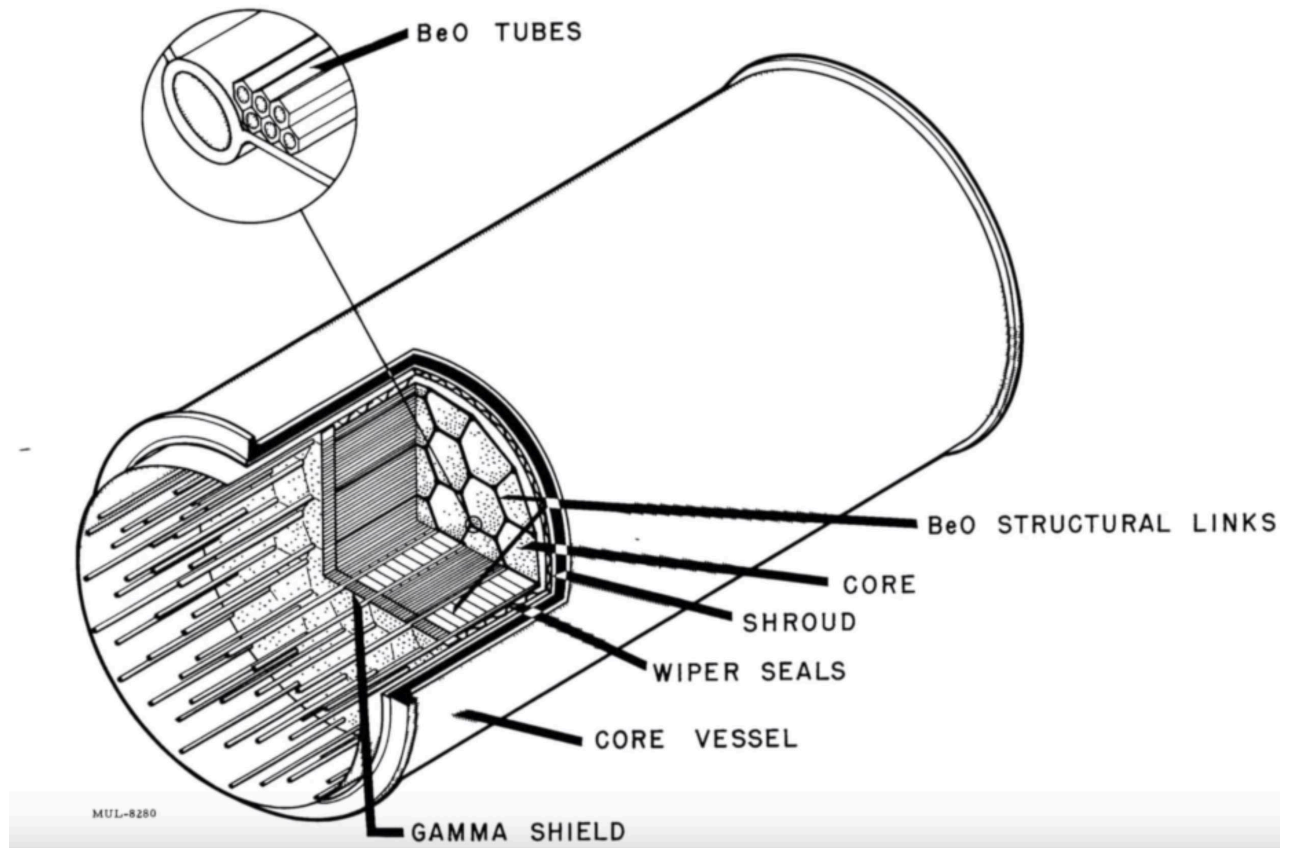

*The nuclear engine of Pluto*

The start-up of this engine has been tested in the USA. It is surrounded by cylindrical elements, all of which can rotate by 90°. Left image: during the transport these elements let the neutrons pass. Just after the release, figure on the right, they form a cylinder surrounding the reactor core, reflecting the neutrons. The reactor then goes into criticality.

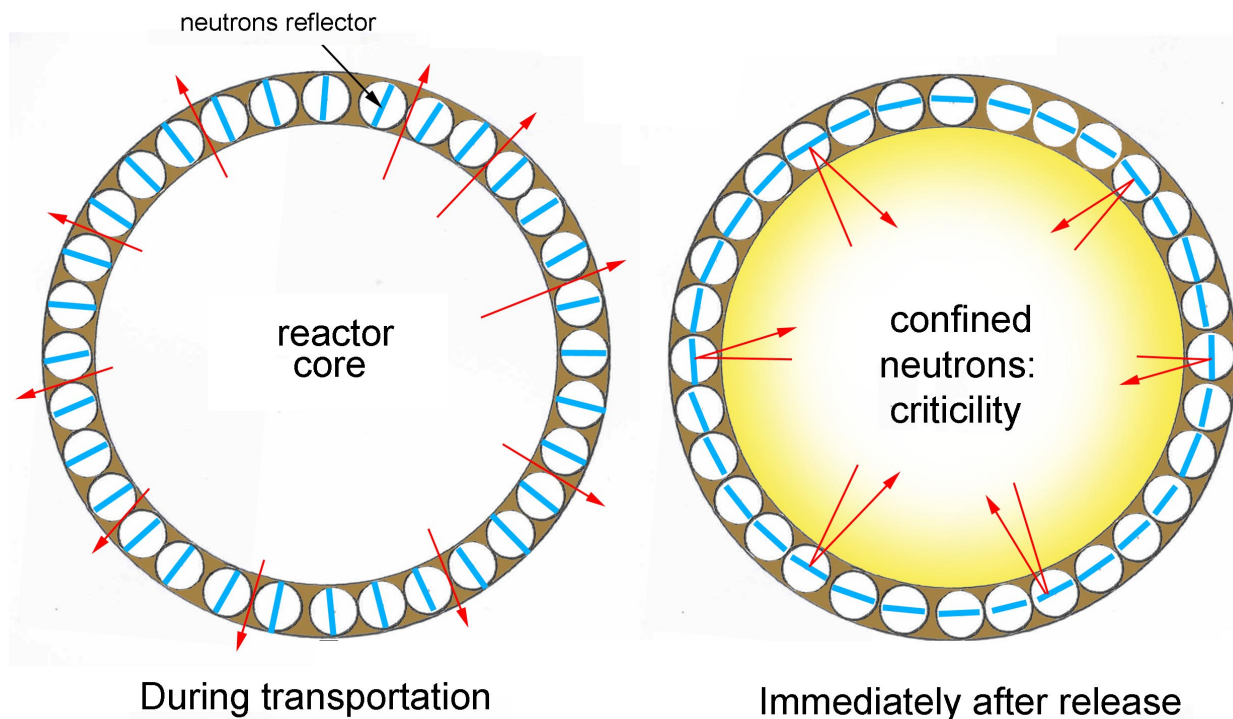

The autonomy of this supersonic cruise missile is then unlimited. It had been designed, in 1957, either to carry about twenty nuclear charges of limited power, or a single charge of 50 megatons. The Russian missile is its miniaturised version.

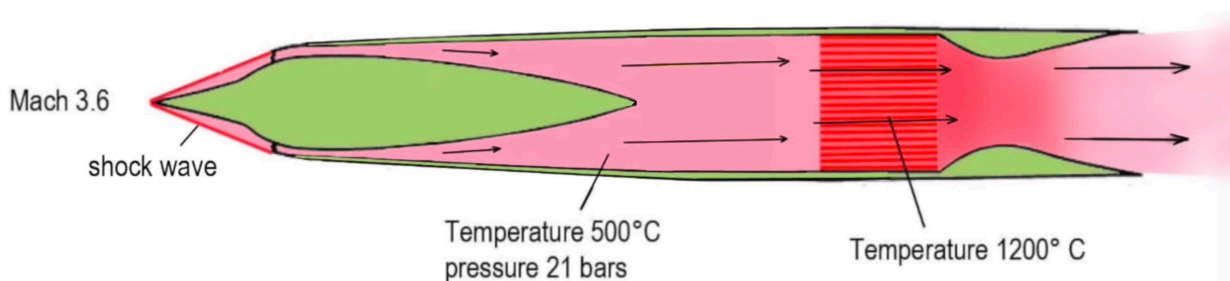

*The Russian nuclear cruise missile.*

As in Pluto's engine, until release, the reactor is kept away from criticality by some kind of "louvers" which surround it. After release, these louvers rotate and become a cylindrical shell reflecting the neutrons.

The device, much less heavy, can then be carried by a bomber. The volume and mass of the electronics are obviously much smaller. After activation, apart from the embarked nuclear charges, its reactor constitutes the dirty atomic bomb par excellence. The Americans, after having finalized the development of the onboard reactor, abandoned the project with the development of ballistic missiles.

Presented today as operational, one of these missiles explodes in 2019 during tests. The French secret services recover nuclear waste in the atmosphere which demonstrates the reality of the project. I received a visit from an army envoy, offering me 3000 euros to write a report on the main features of these new Russian weapons, plus a proposal to hold seminars, with a high-end consulting engineer's salary, intended to bring our military engineers up to speed.

*Offer not followed by effect.*

## **Conclusion**

The conclusion is that, contrary to the article that appeared in a recent issue of Scientific American, President Putin did not bluff, in 2018. To avoid having to embark on a new ruinous arms race, with the aim of establishing parity, anti-missile weapon against anti-missile weapon, the Russians have opted for the qualitative instead of the quantitative. At the cost of military expenditure ten times lower than that of the United States, with these hypersonic weapons and this underwater drone, they have unstoppable retaliation possibilities, too damaging for anyone to want to crush Russia. That was their goal. Do these new weapons increase the risk of conflagration? No more and no less than the previous ones. In any case, current events show that there is no need for nuclear weapons to continue killing each other, more than ever. What remains remarkable is the amount of money and brainpower everywhere devoted to creating death devices, instead of developing new sources of energy. On this point, I predict that one day we will succeed, from chemical explosives activating MHD compressors, inspired by the Z-machine, to initiate aneutronic fusion reactions of a Boron-Hydrogen mixture, this technique leading to "green" thermonuclear bombs, and ... miniaturizable. In 2008 we try to attract the attention of the Ministry of Research on this formula, with the aim of leading to the source of energy, inexhaustible and without waste, that the world awaits. The Army, at once, intervenes:

- Bombs, first, energy, then.